

# H10

## Tabouret pieds bois - h.75cm

Le tabouret H10, accueillant et configurable à l'infini.



### Fabrication

100% France

### Utilisation

Intérieure

### Entretien

Frotter avec un chiffon doux légèrement humide.  
Laisser sécher.

Modèle H10 - Tabouret pieds bois - h.75cm  
Finitions pieds bois et assise hêtre.

## Spécifications









### Assises

Bois moulé ép. 10mm

 Hêtre	 Hêtre teinté bleu	 Hêtre teinté brun
 Hêtre teinté cerise	 Hêtre teinté jaune	 Hêtre teinté noir
 Hêtre teinté rose	 Hêtre teinté sable	 Hêtre teinté vert

### Pieds

Bois massif

 Hêtre	 Hêtre teinté bleu	 Hêtre teinté cerisier
 Hêtre teinté cerise	 Hêtre teinté jaune	 Hêtre teinté noir
 Hêtre teinté rose	 Hêtre teinté sable	 Hêtre teinté vert

### Logistique

Poids : 6 kg  
Livré démonté.

Délai de livraison : 2 semaines

Dim. packaging carton :  
560x520

### Dimensions

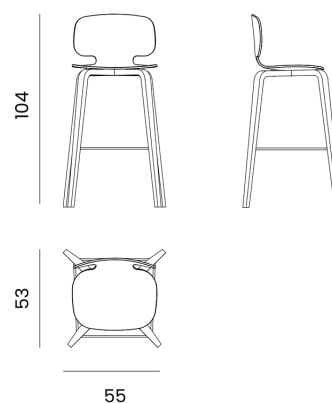

# lcf

la chaise française  
24 rue Saint-Bernard  
10310 Clairvaux, FRANCE

### Contact

jeancharles@lachaisefrançaise.fr  
Tel +33 (0) 7 72 66 55 93